



HORSTMANN

ServicePlus S11R & S17R Series 2 Installation Instructions



Horstmann Controls ServicePlus single channel service interval timeswitches have been developed to facilitate compliance with the Gas Safety (Installation and Use) Regulations 1998. The device is not intended to replace the normal servicing regime already in operation but is intended to act as a supplementary aid to enabling compliance.

Installation and connection should only be carried out by a suitably qualified person and in accordance with the current edition of the IEE wiring regulations.

WARNING: Isolate mains supply before commencing installation.

Fitting the backplate

Once the backplate has been removed from the packaging please ensure the timeswitch is re-sealed to prevent damage from dust and debris.

The backplate should be fitted with the wiring terminals located at the top and in a position that allows a total clearance at last 50mm around the unit.

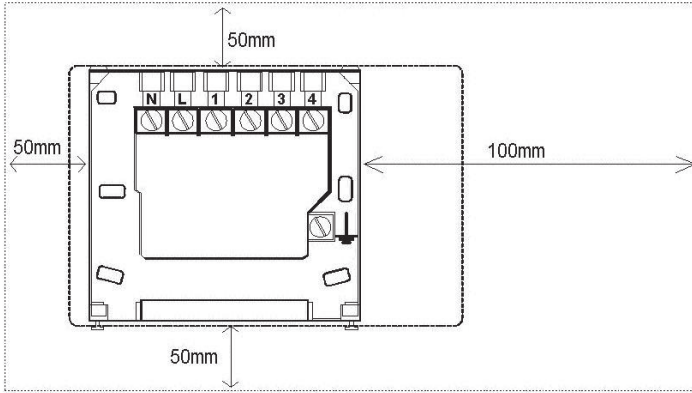

Direct wall mounting

Offer the backplate to the wall in the position where the timeswitch is to be mounted, remembering that the backplate fits to the left hand end of the control. Mark the fixing positions through the slots on the backplate (fixing centres of 60.3mm), drill and plug the wall, then secure the backplate in position. The slots in the backplate will compensate for any misalignments of the fixings.

Wiring box mounting

The backplate may be fitted directly onto a single gang steel flush wiring box complying with BS4662, using two M3.5 screws. CentaurPlus controls are suitable for mounting on a flat surface only; they must not be positioned on a surface mounted wall box or on unearthed metal surfaces.

Electrical connections

All necessary electrical connections should now be made. Flush wiring can enter from the rear through the aperture in the backplate. Surface wiring can only enter from beneath the time control and must be securely clamped. The mains supply terminals are intended to be connected to the supply by means of fixed wiring. Recommended cable sizes are 1.00 or 1.5mm²

ServicePlus timeswitches are double insulated and do not require an earth connection but an earth connection is provided on the backplate for terminating cable earth connectors. Earth continuity must be maintained and all bare earth connectors must be sleeved. Ensure no earth conductors are left protruding outside the central space enclosed by the backplate.

Internal wiring diagram - S11R & S17R Series 2

The ServicePlus S11R and S17R time switches have standard volt free switching ON/OFF contacts. Ideal for combi boiler installations while also supplying the mains voltage boiler connection.

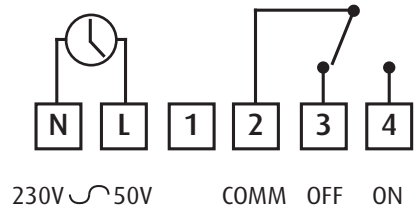

New installations

Example circuit diagrams for some typical installations are shown opposite. These diagrams are schematic and should be used as a guide only.

Please ensure that all installations comply with current IEE regulations.

For reasons of space and clarity not every system has been included and the diagrams have been simplified - for example some Earth connections have been omitted.

Other control components shown in the diagrams, i.e. Valves, Room Stats etc are general representations only. However the wiring detail can be applied to the corresponding models of most manufacturers, for example Honeywell, Danfoss Randall, ACL Drayton etc.

Cylinder and Room Thermostat key;

C = Common; CALL = Call for heat or break on rise; SAT = satisfied on rise; N = neutral.

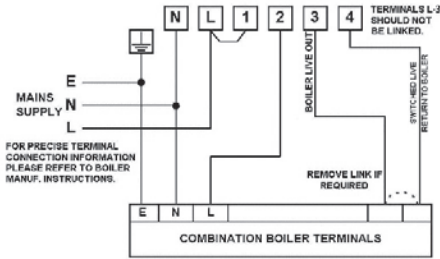

1. Typical combination boiler installation

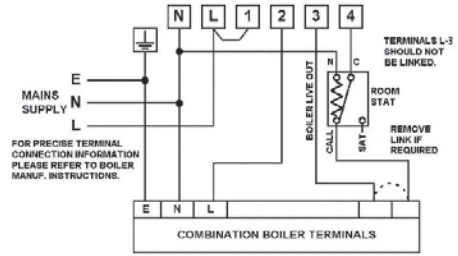

2. Typical combination boiler installation with Room Stat

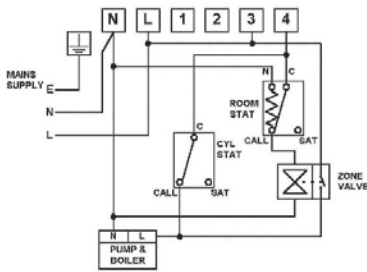

3. Fully Pumped System with Room Stat and two port spring return valve (with auxiliary switch) on Heating circuit

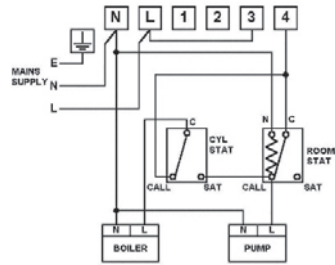

4. Gravity primary with pumped Heating via Room Stat and Cylinder Stat

Commissioning the timeswitch

Ensure all dust and debris has been cleared away from the work area before removing the time switch from its packaging.

Rear view of ServicePlus timeswitch

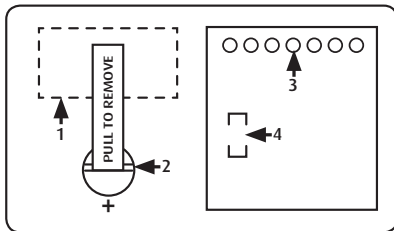

- 1 - RATINGS LABEL
- 2 - BATTERY
- 3 - CONNECTOR PINS
- 4 - PRODUCTION DATE LABEL

Battery reserve

The battery must be commissioned prior to fitting the control to the backplate. This is achieved by the means of a commissioning strip situated in the back of the unit. Pull out the battery commissioning strip at the back of the timeswitch and re-insert the battery; the reserve is now activated. When the timeswitch is running the battery reserve clock display will disappear. This is to prolong the life of the battery.

Fitting the timeswitch

If surface wiring has been used, remove the knockout/insert from the bottom of the timeswitch to accommodate it.

Loosen the two 'captive' retaining screws on the bottom of the backplate. Now fit the timeswitch to the backplate, ensuring the lugs on the backplate engage with the control.

Swing the bottom of the control into position ensuring that the connection pins on the back of the unit locate into the terminal slots in the backplate.

Tighten the two captive retaining screws to fix the unit securely.

Then switch on the mains supply.

On completion of the installation please reset the timeswitch - detailed below.

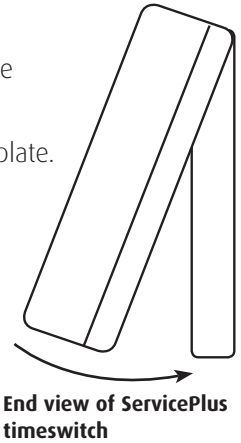

Resetting the timeswitch

On the ServicePlus press the SET and SELECT buttons together. Then release the buttons and the timeswitch will return to preset factory settings.

The preset factory settings are illustrated on page 5 or 6 of the USER GUIDE.

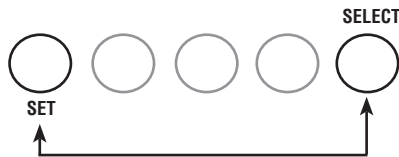

The unit can now be programmed to suit the user's requirements.

Please refer to the User Guide provided.

General information

Before handing over the installation to the user, always ensure that the system responds correctly on all control programmes and that other electrically operated equipment and controls are correctly adjusted.

Explain how to operate the controls and hand over the users operating instructions to the user.

Specification

ServicePlus S11R & S17R

CONTACT RATING:

3 (1) Amps 230V AC

CONTACT TYPE:

Micro-disconnection

Voltage free with optional
mains switch supply

SUPPLY:

230V AC 50Hz only

Pollution Degree 2

CLASS A SOFTWARE:

Type 1 control

OPERATING TEMPERATURE RANGE:

0°C to +40°C

BATTERY LIFE:

10 months continuous operation
(minimum)

CASE MATERIAL:

Thermoplastic, flame retardant

DIMENSIONS:

84mm x 150mm x 29mm

CLOCK:

12 hour AM/PM

Auto BST / GMT changeover

DISPLAY

Back lit liquid crystal

DISPLAYED TIME ADJUSTMENTS:

1 minute steps

SWITCHED TIME ADJUSTMENTS:

10 minute steps

OPERATING PERIODS PER DAY

3 per day

OVERRIDE:

1 hour boost, 1 hour extension to On
period, instant advance

MOUNTING:

Industry standard 6 terminal plug in wall
plate



HORSTMANN

Horstmann Controls

South Bristol Business Park, Roman Farm Road, Bristol BS4 1UP

E-mail: sales@horstmann.co.uk

Web site: www.horstmann.co.uk

